

FUSION

USER MANUAL

SCC P/N
20-56435

FUSION SELF-SERVICE HIGH-VOLUME REFRIGERATED DISPLAY CASES (REMOTE UNITS)

PLEASE NOTE THE FOLLOWING:

1. YOUR SPECIFIC MODEL NUMBER IS LOCATED ON THE SERIAL LABEL. HOWEVER, LABEL LOCATIONS MAY VARY DEPENDING UPON MODEL.
2. CASES SHOWN IN THIS MANUAL REFLECT FULL & OPEN END PANELS / STRAIGHT OR ANGLED BASES.
3. NOT ALL MODELS COVERED BY THIS OPERATING MANUAL ARE SHOWN ON THIS COVER SHEET.

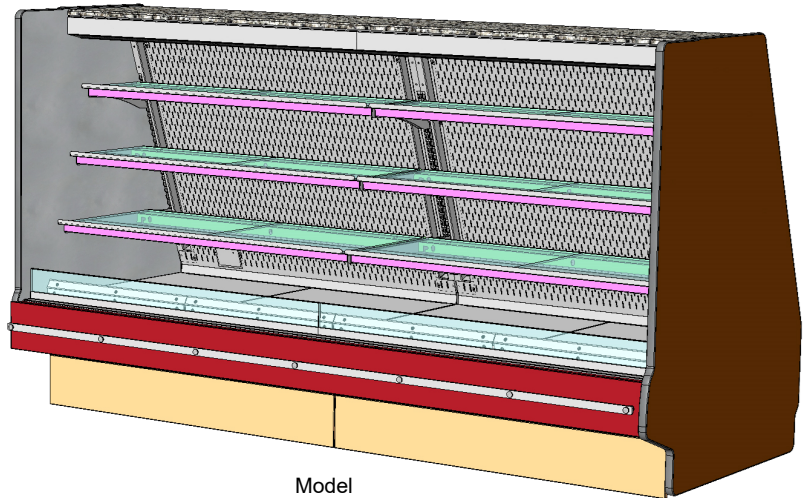

Model
GHSSV856RLB.6611B

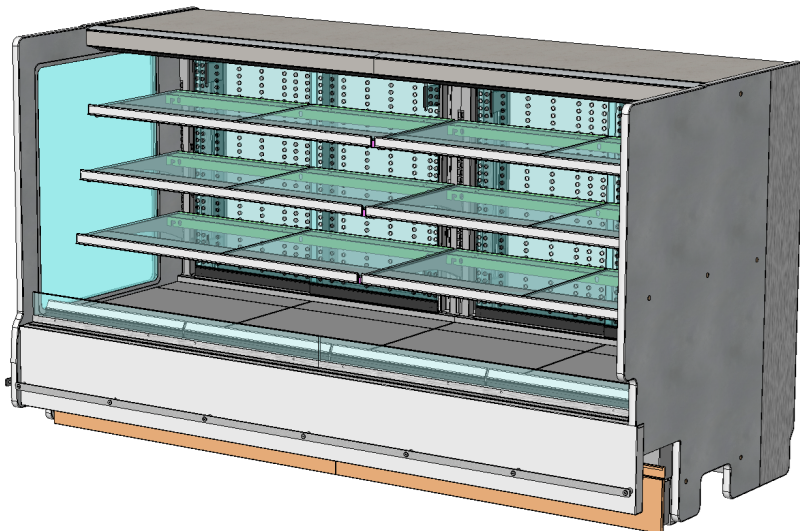

Model
GHSSV856RLB.6988D

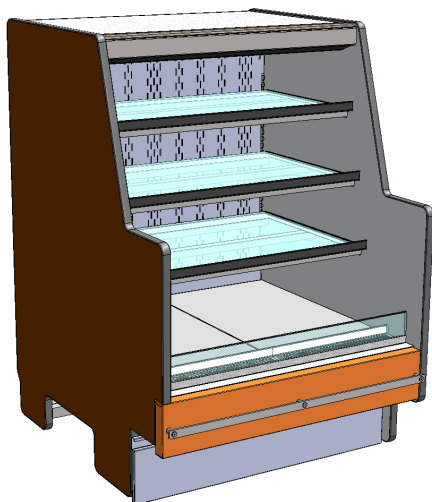

Model
GHSSV356RLB

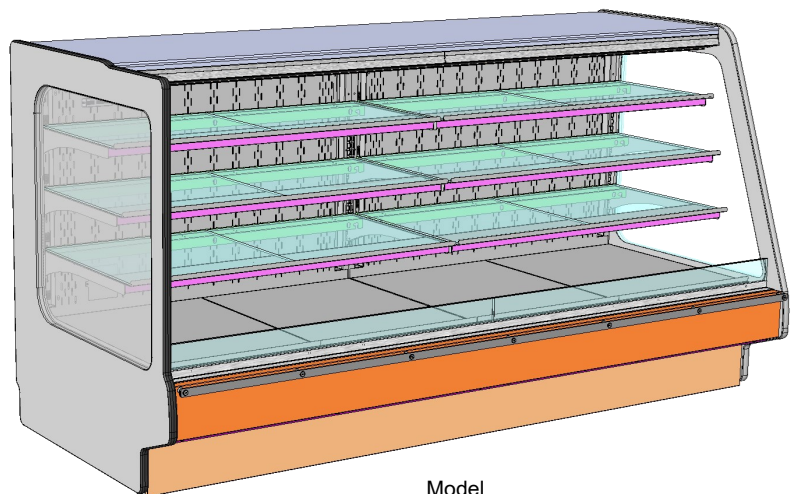

Model
GHSSV852RLB

Structural Concepts®

DELIVERING FRESH. ALWAYS.™ Structural Concepts Corp. · 888 E. Porter Rd · Muskegon, MI 49441 Phone: 231.798.8888 Fax: 231.798.4960 · www.structuralconcepts.com

TABLE OF CONTENTS

TABLE OF CONTENTS	2
OVERVIEW / TYPE / COMPLIANCE / WARNINGS / PRECAUTIONS / WIRING / PLUGS	3-4
INSTALLATION: REMOVAL FROM SKID, REMOVING VERTICAL LOWER FRONT PANELS	5
INSTALLATION, CONT'D: BOLTING AND CAULKING UNITS TOGETHER	6
INSTALLATION, CONT'D: GLASS SHELVING / ELEC LAYOUT / LED DRIVERS / OPTIONAL BALLASTS	7
INSTALLATION, CONT'D: ELECTRICAL LAYOUT / LED DRIVERS / OPTIONAL BALLASTS	8
INSTALLATION, CONT'D: FRAME SUPPORT RAILS / SEALING TO FLOOR	9
INSTALLATION, CONT'D: REFRIGERATION LINES / STUB-UPS / DRAINS / WIRING DIAGRAMS / VENTILATION	10
INSTALLATION, CONT'D: DISPLAY CASE START-UP	11
MAINTENANCE FUNDAMENTALS: LED LIGHTS / BRACKETS / SHELVES	12
MAINTENANCE FUNDAMENTALS, CONT'D: DRAIN / TXV / REFRIGERATION LINES / SHUT-OFF VALVE, TROUGH, SOLENOID, ETC.....	13
MAINTENANCE FUNDAMENTALS, CONT'D: REAR DOORS / PERFORATED ACRYLIC PLENUM .	14
GENERAL CLEANING (TO BE PERFORMED BY STORE PERSONNEL)	15
ENGINEERED (SYNTHETIC) QUARTZ CARE AND MAINTENANCE (TO BE PERFORMED BY STORE PERSONNEL)	16
TROUBLESHOOTING (TO BE PERFORMED BY STORE PERSONNEL)	17
GENERAL CLEANING (TO BE PERFORMED BY TRAINED SERVICE PROVIDERS ONLY)	18
TROUBLESHOOTING (TO BE PERFORMED BY TRAINED SERVICE PROVIDERS ONLY)	19-20
SERIAL LABEL INFORMATION & LOCATION	21
PROGRAMMABLE CONTROLLER (SELECT, CLICK ON OR SCAN QR CODE FOR INFORMATION)	22
TECHNICAL SERVICE CONTACT INFORMATION / WARRANTY INFORMATION	23

OVERVIEW

- These Structural Concepts cases are designed to merchandise packaged products at 41 °F (5 °C) or less product temperatures (unless custom cases with wire rack shelving).
- Product must be pre-chilled to 41 °F (5 °C) or less before being placed in merchandiser.
- Cases should be installed and operated according to this operating manual's instructions to ensure proper performance. Improper use will void warranty.

NSF/ANSI TYPE I vs. II ENVIRONMENTAL CONDITIONS

This unit is designed for the display of products in ambient environmental conditions where temperatures and relative humidity are maintained within a specific range.

- NSF/ANSI Type I Conditions: Product is displayed in store conditions with maximum ambient temperature of 75 °F (24 °C) and relative humidity of 55%.

- NSF/ANSI Type II Conditions: Product is displayed in store conditions with maximum ambient temperature of 80 °F (27 °C) and maximum relative humidity of 55%.
- If unsure if your unit is classified as NSF/ANSI Type I or Type II, see tag next to serial label on your case.

COMPLIANCE

- Performance issues when in violation of applicable NEC, federal, state and local electrical and plumbing codes are not covered by warranty.
- See below compliance guideline.

WARNINGS

- This page contains important warnings to prevent injury or death. Please read carefully!

PRECAUTIONS and WIRING DIAGRAMS

- See next page for **PRECAUTIONS** and **WIRING DIAGRAM** information.



COMPLIANCE
This equipment **MUST** be installed in compliance with all applicable NEC, federal, state and local electrical and plumbing codes.



WARNING
Risk of electric shock. Disconnect power before servicing unit. **CAUTION!** More than one source of electrical supply is employed with units that have separate circuits. *Disconnect ALL ELECTRICAL SOURCES before servicing.*



WARNING
Hazardous moving parts. Do not operate unit with covers removed. Fan blades may be exposed when deck panel is removed. Disconnect power before removing deck panel.



WARNING
This product can expose you to chemicals, including Urethane (Ethyl Carbamate), which are known to the state of California to cause cancer and birth defects or other reproductive harm. For more information go to P65Warnings.ca.gov.



WARNING
Condensate pan and overflow condensate pans are **HOT!** Disconnect and allow to cool before cleaning or removing from case.

PRECAUTIONS

- Following are important precautions to prevent damage to unit or merchandise. Read carefully!
- See previous page for specifics on **OVERVIEW**, **CONDITION TYPE**, **COMPLIANCE** and **WARNINGS**.

WIRING DIAGRAM

- Each case has its own wiring diagram folded and in its own packet. It may be placed near ballast box, field wiring box, raceway cover, or other related location.

REFRIGERANT DISCLOSURE STATEMENT

- This equipment is prohibited from use in California with any refrigerants on the "List of Prohibited Substances" for that specific end-use, in accordance with California Code of Regulations, title 17, section 95374.
- This disclosure statement has been reviewed and approved by Structural Concepts and Structural Concepts attests, under penalty of perjury, that these statements are true and accurate.



CAUTION! GFCI BREAKER REQUIREMENT
 If N.E.C. (National Electric Code) or your local code requires GFCI (Ground Fault Circuit Interrupter) protection, you **MUST** use a GFCI breaker in lieu of a GFCI receptacle.

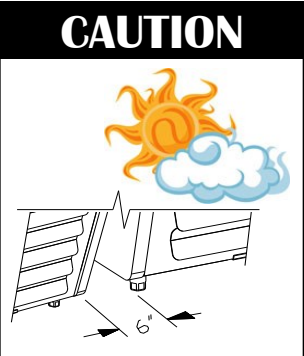

CAUTION! ADVERSE CONDITIONS / SPACING ISSUES

- Performance issues caused by adverse conditions are **NOT** warranted.
- To prevent damage to end panels due to condensation, apply industrial grade silicone sealant and tightly join to opposite end panels. When not adjoining cases, keep end panels at least 6" away from walls/structures. Rear panels must also be kept at least 6" from walls and structures.
- Case must not be exposed to direct sunlight or any heat source.
- To maintain proper case temperature, keep case at least 15-feet from exterior doors, overhead HVAC vents or any air curtain disruption.
- Self-contained case clearance: 6" min. air intake / 6" min. air discharge.



CAUTION! POWER CORD AND PLUG MAINTENANCE
 Risk of electric shock. If cord or plug becomes damaged, replace only with cord and plug of same type.



CAUTION! DO NOT RELY ON THERMOMETERS OR THERMOSTATS FOR PRODUCT (FOOD) TEMPERATURES.

- Thermometers & thermostats reflect air temperatures **ONLY**.
- For **ACTUAL** product (food) temperatures, use a calibrated food probe thermometers **ONLY**.
- For accurate readings, **DO NOT** use infrared food thermometers.

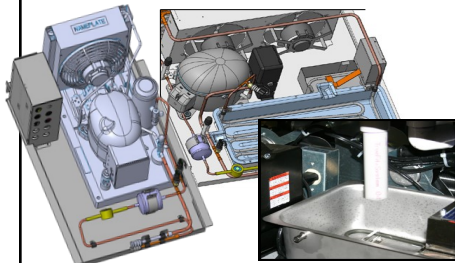

CAUTION! CHECK CONDENSATE PAN, ITS POSITION & PLUG!
 Water on flooring can cause extensive damage!

- Before powering up case, check that condensate pan is positioned directly under case's condensate drain.
- Before powering up case, check that condensate pan's electrical plug is **SECURELY** connected to condensate system's receptacle.
- If wicking material is used in condensate pan, check that it is secure.

INSTALLATION: REMOVAL FROM SKID, REMOVING VERTICAL LOWER FRONT PANELS

1. Remove From Skid (Rails or Levelers)

- Remove shipping brace that may be securing case to skid.
- Support case to prevent tipping.
- **Caution!** Frame support rails (or levelers) can be damaged if case hits floor with heavy force!
- Carefully slide unit to rear of skid and tip backward off skid.
- Illustration may not reflect every feature or option of your particular case.
- **Note:** Case can be repositioned with pallet truck when front lower panel is removed. Blocking may be necessary to obtain adequate height.

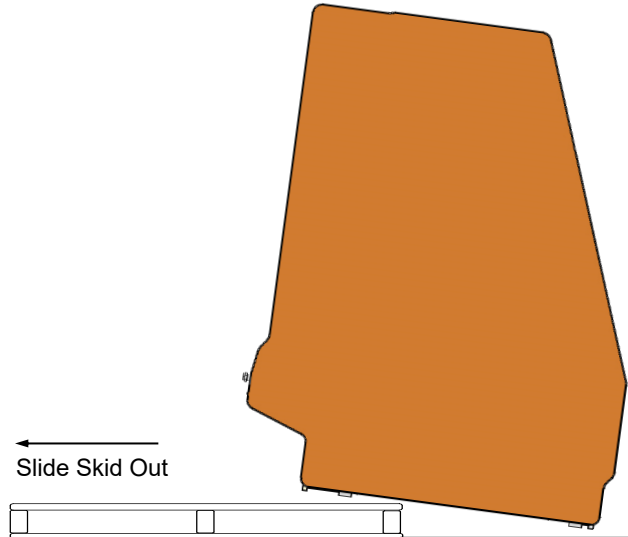

2. Removing Vertical Lower Front Panels

- No screw removal required: Simply lift lower front panel up (off hooks) and out (away from case).
- Certain models have hook/magnet/slot attachment method (shown at immediate right).
- Other models have just hook/slot attachment method (shown lower-right).

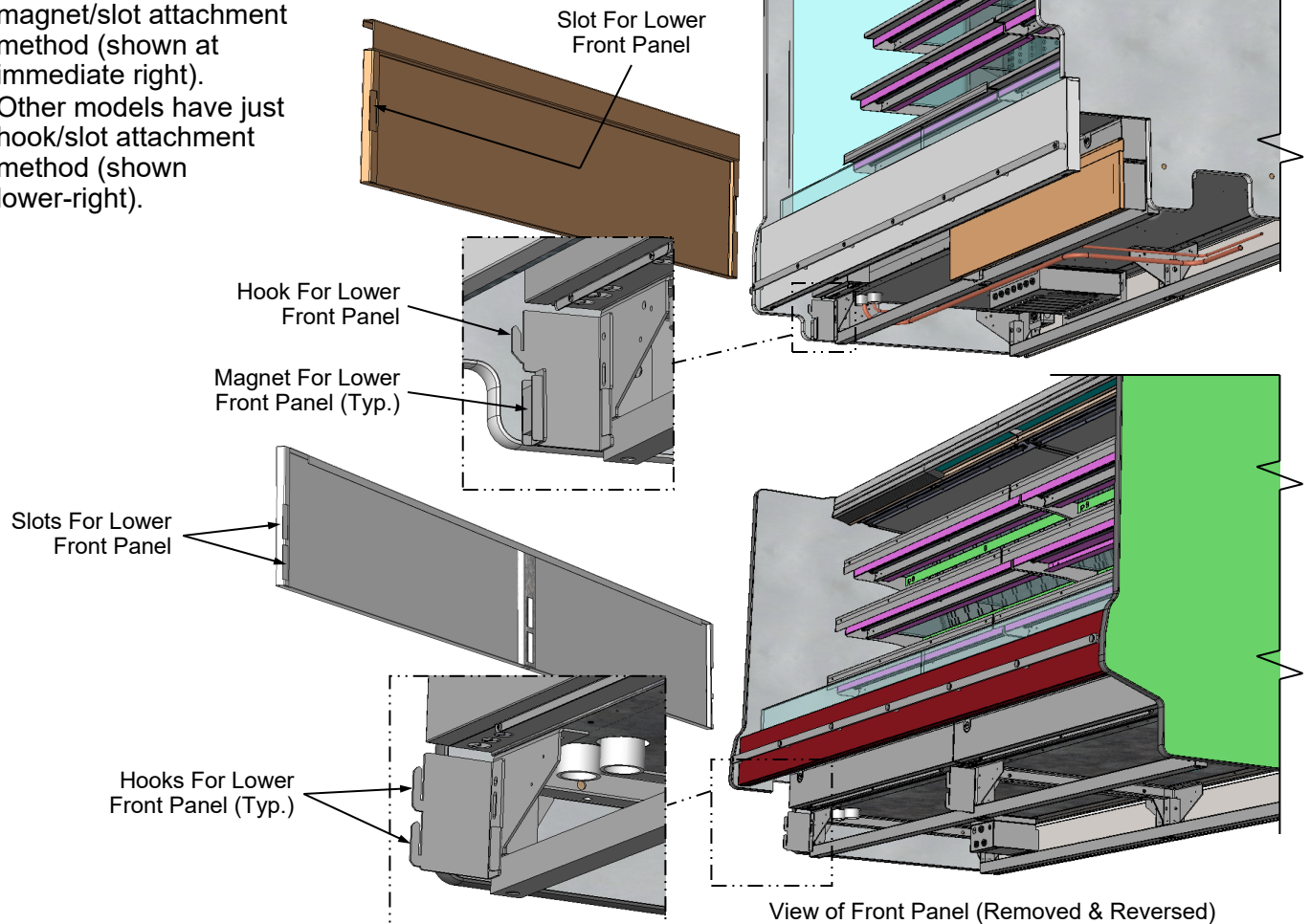

INSTALLATION, CONT'D: BOLTING AND CAULKING UNITS TOGETHER

3. Bolting and Caulking Units Together

Follow these steps to assure a secure, level lineup.

- A. Begin all lineups leveling from highest point of floor.
- B. After the 'first' case is level, apply industrial grade butyl caulk on non-visible areas (at case end). Use industrial grade silicone sealant on visible areas (at case end).
- C. Form Two (2) Caulk/Sealant Lines: (Sanitation and Refrigeration). See illustration at mid-right for outline of caulk/sealant lines.
- D. Line up 'second' case bolt-hole to bolt-hole to 'first' case.
- E. Using SCC-supplied bolts (found in hole locations OR in installation packet), insert bolts in bolt hole locations (shown at top-right). You may need to remove decking to access lower bolt holes.
- F. Caution! Front of cases **MUST** be flush with each other! After leveling, all cases to be same height.
- G. Using SCC-supplied nuts & bolts, **lightly tighten** each of the 5 to 8 bolts in a cross-wise pattern. Work your way around the pattern, tightening more firmly at each pass. Do not firmly tighten one bolt and then start on the next!
- H. After the cases are bolted together, level the 'second' case. Repeat this process for each case to be adjoined.

Approximate hole locations pointed at with arrows (←) for bolting units together.

Sanitation Bead



Refrigeration Bead

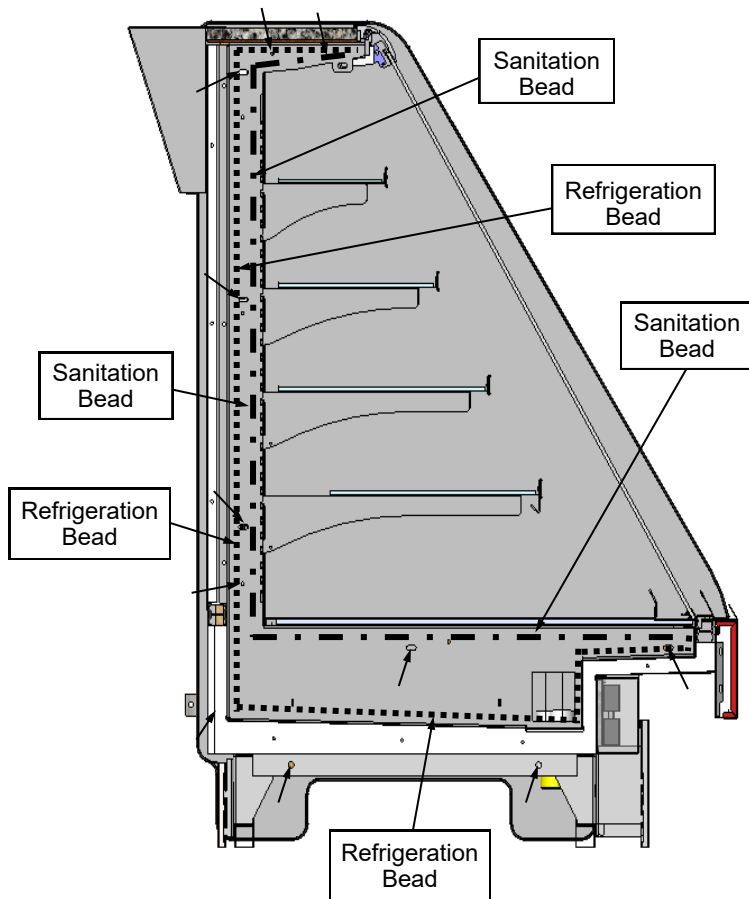

--- Sample Flat Glass Unit ---

Note: Illustration shown may not exactly reflect every feature or option of your particular case. However, general bead layout applies.

4. Glass Shelving

Certain models have glass shelving. Glass shelving will be packed separately for shipment.

- Caution! Carefully remove from packaging.
- Grasp firmly and carefully install.
- *Caution! Check that plastic edging is intact before placing glass shelving onto brackets!*
- Plastic edging must NOT be removed from glass shelves. Contact Structural Concepts for replacement edging (see *TECHNICAL SERVICE CONTACT INFORMATION* section).
- Check that glass shelving is in proper position before placing product in case.
- See illustrations at right showing both curved and flat front glass (optional).

- Note: Wiring process must be performed by certified electrician only.

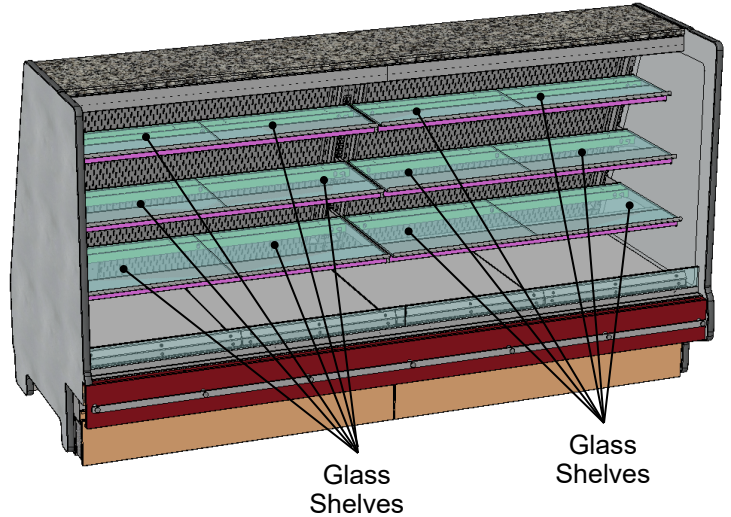

5. Electrical Layout - Option #1

LED Drivers (and/or Optional Ballasts)

- Remove FRONT panel (lift up and off - no screw removal is required).
- Stub-up connections are in ballast box.
- Remove ballast box / LED driver box cover.
- Knockouts are on the underside of ballast box / LED driver box making electrical connections.
- Voltage rating is on serial label at case rear.

Note: Illustration below may not exactly reflect every feature or option of your particular case.

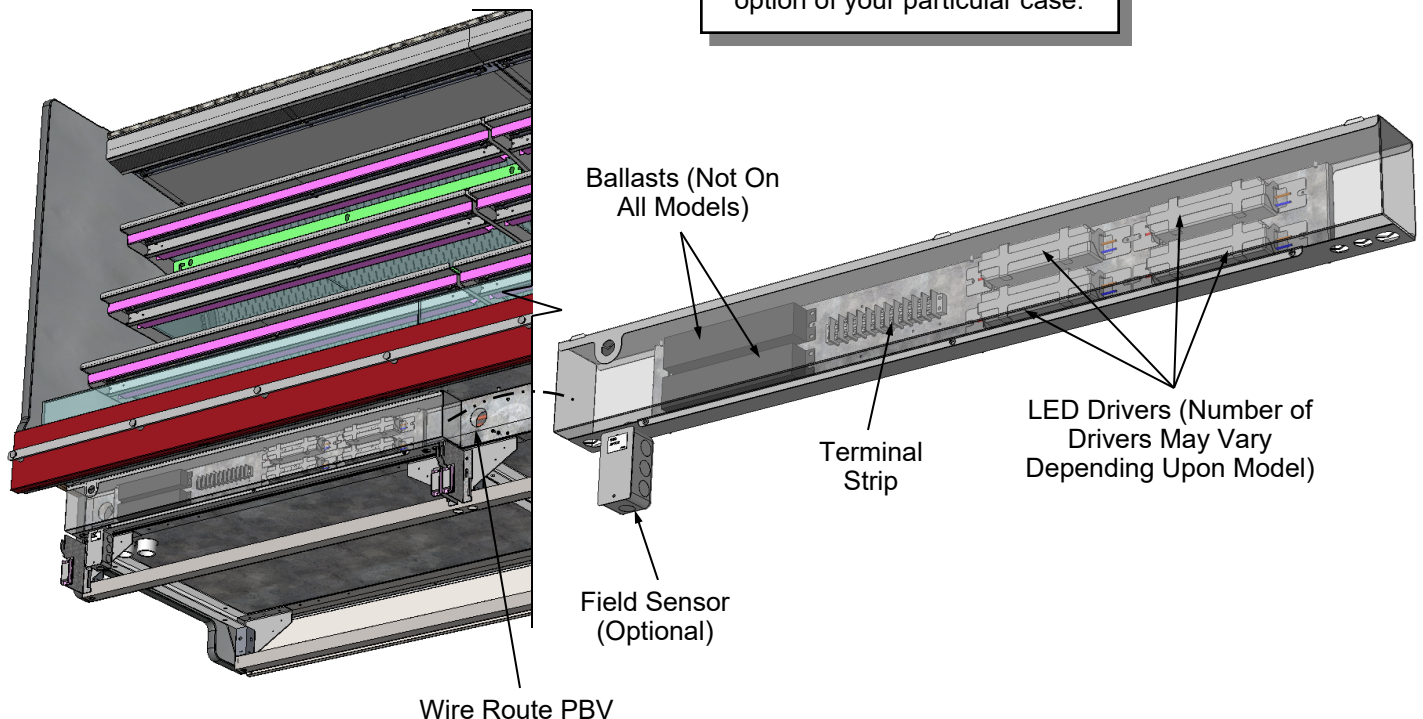

6. Electrical Layout - Option #2

LED Drivers (and/or Optional Ballasts)

- Remove REAR panel (lift up and off - no screw removal is required).
- Stub-up connections are in LED driver box.
- Remove LED driver drawer screws and slide out box to access.
- Knockouts are at rear of field access box (for taking electrical connections).
- Voltage rating is on serial label at case rear.
- Note: Wiring process must be performed by certified electrician only.

LED Drivers (Number of Drivers May Vary Depending Upon Model)

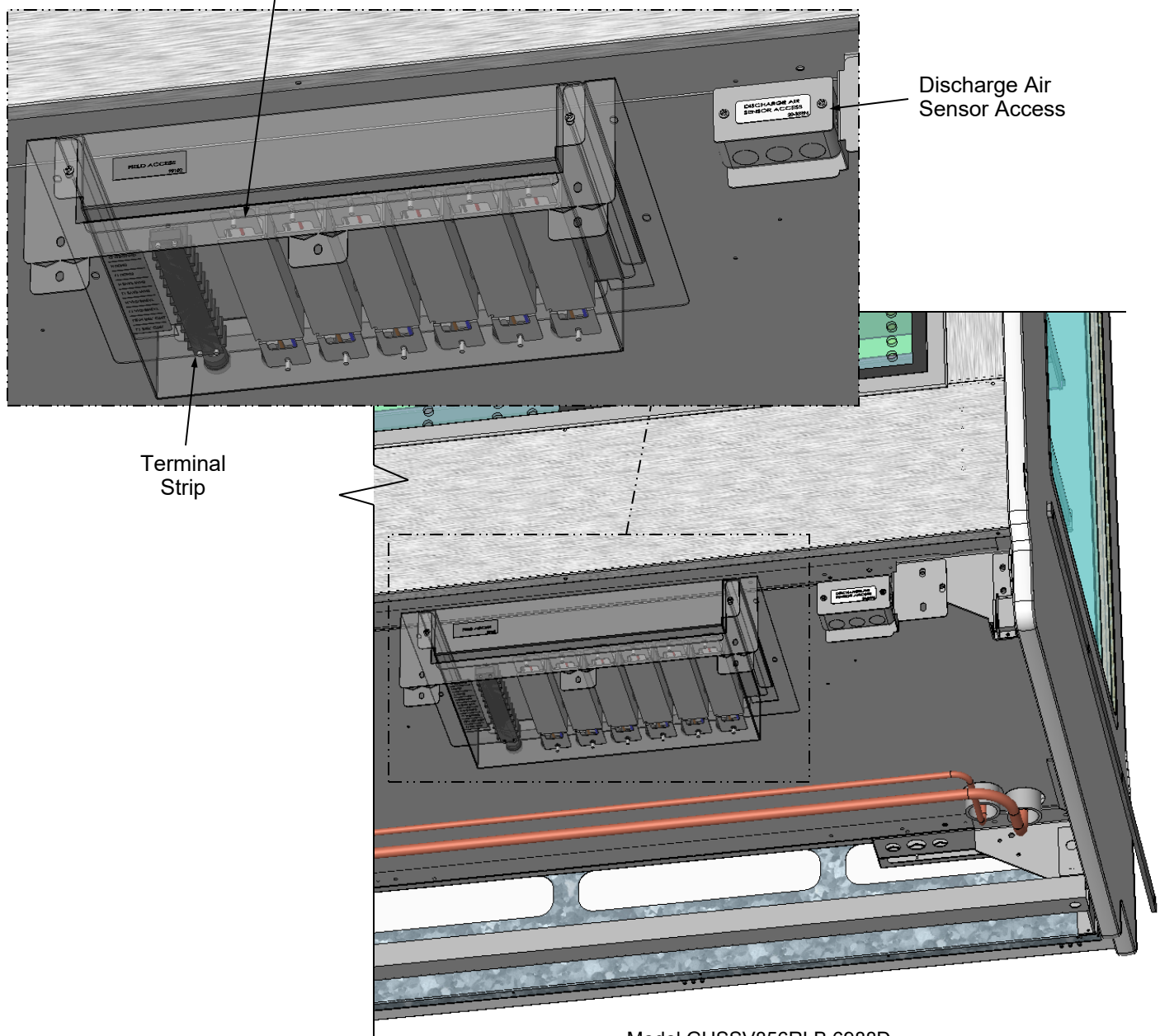

7. Cases With Frame Support Rails: Shim

- Partially disassembled illustration at right shows case with frame support rails.
- Shims will be provided with all cases that have frame support rails.
- Use shims to level case.
- ***Note: After case is in position, it must be sealed to floor to prevent entry or leakage of liquid or moisture.***

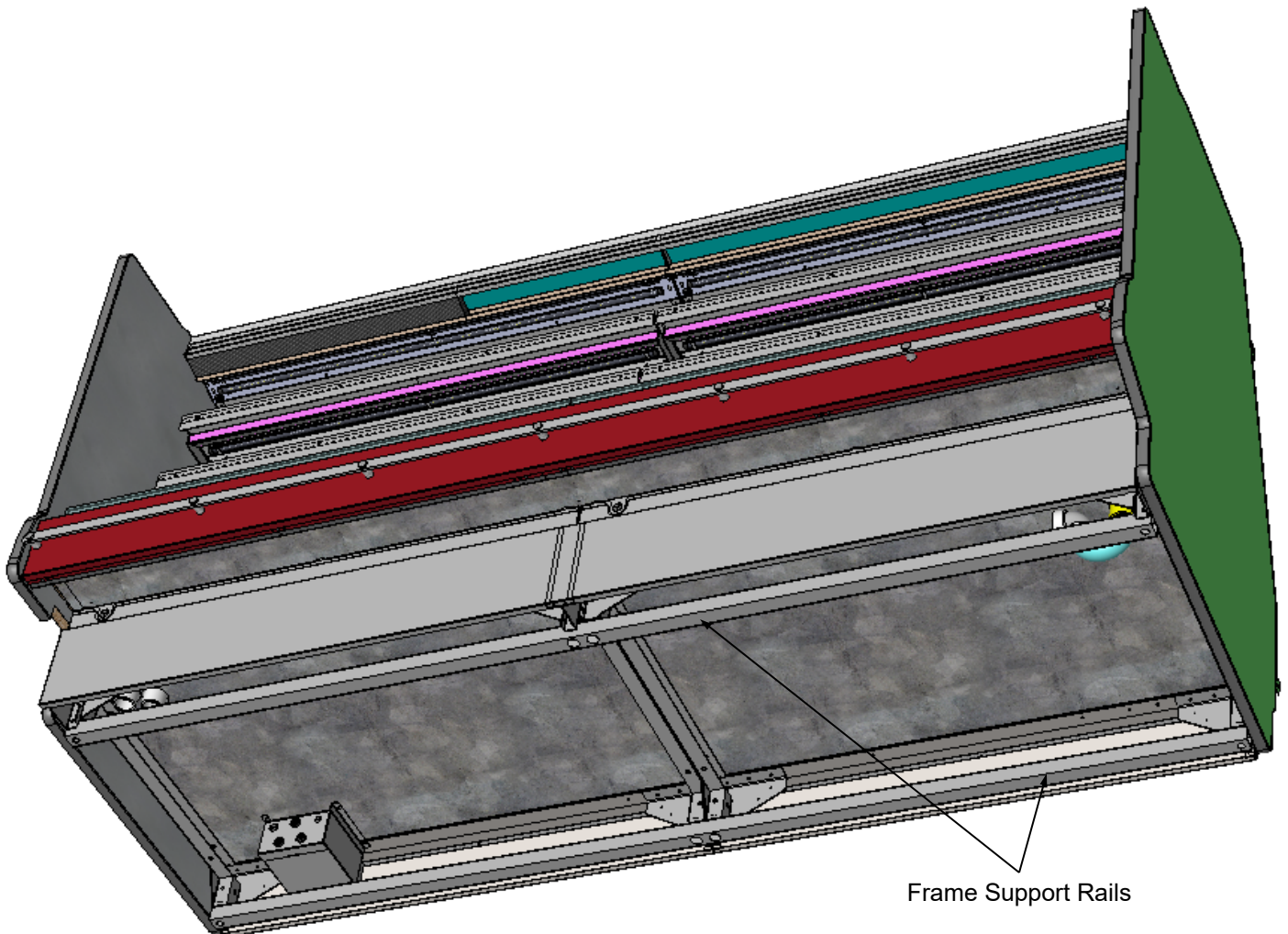

8. Refrigeration Line Stub-Up Connections (Remote Units)

- Remove front panel.
- Refrigerant stub-up access opening is at the front on the left hand side of the base (see illustration at top-right).
- Stub-up connections are accessed from inside the case.
 - Remove interior decks.
 - Remove fan shroud assembly.
- Line connections are in the tub front, on the left hand side
- Remove foam material from the entry hole provided in the tub drain trough.
- Route refrigerant lines through access hole.
 - Run case-to-case connections through cutouts in base.
 - Sweat the high and low pressure connections.
- Fill access hole with suitable filler to insure watertight integrity of tub.
- Illustration at top-right may not reflect every feature or option of your particular case.

9. Refrigeration Drain Connection (Remote Units)

- Depending upon drain access needs, either front or rear panel may be removed to gain access to drain stub-up.
- 1.5" male PVC stub-up connection is under the case on the right hand side.
- Drain stub-up may be at case center in extended length cases.
- Connect tub drain to floor drain. Maintain 1/4"-fall per foot to provide proper drainage.
- Illustration at top-right may not reflect every feature or option of your particular case.

10. Electrical Wiring Diagram

- Each case has its own wiring diagram folded and in its own packet.
- Wiring diagram placement may vary; it may be placed near condenser fan cover, ballast box, raceway cover, or other related location.

Note: Illustration below may not exactly reflect every feature or option of your particular case.

Refrigeration Line Stub-Ups Access

Drain Stub-Up
(May Be At Case Center In Extended Length Cases)

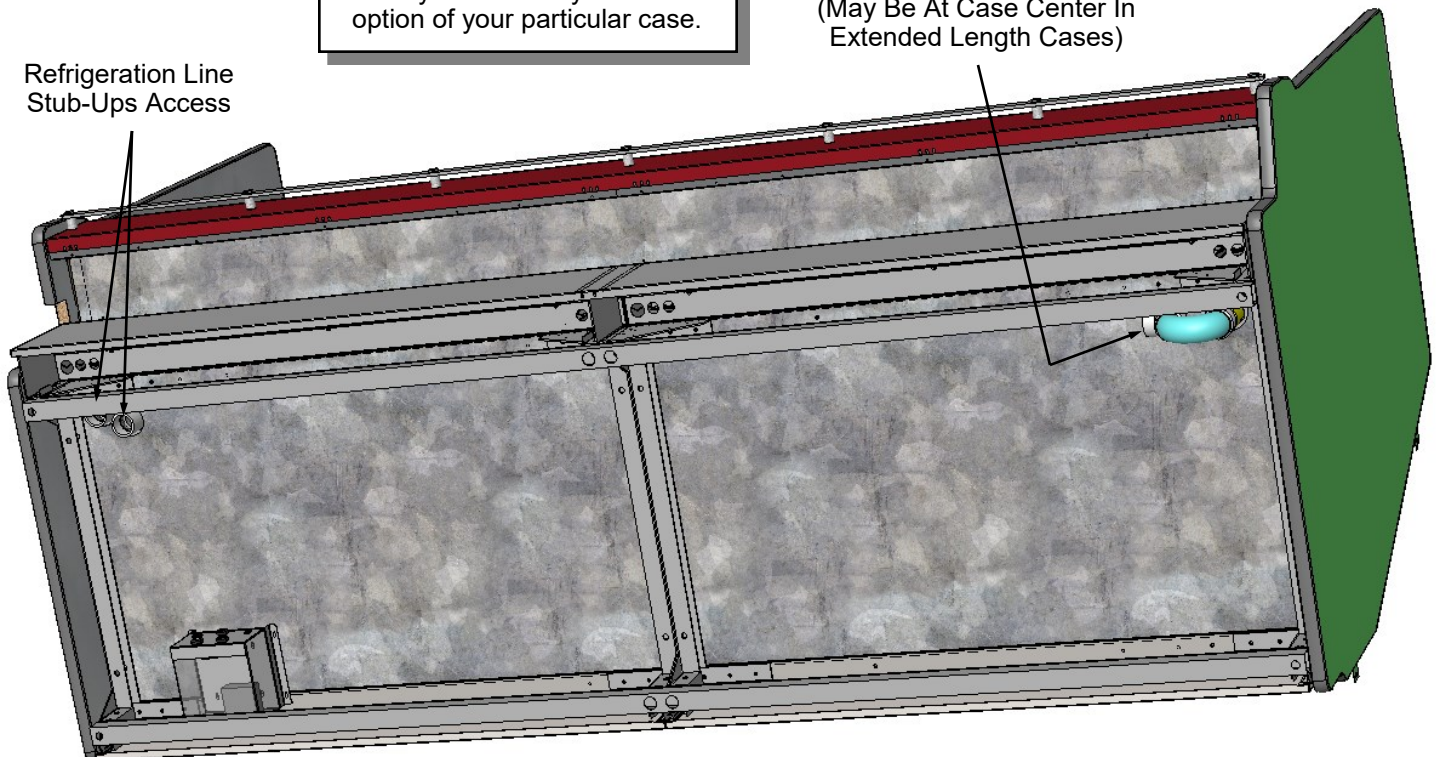

11. Display Case Start-Up

A. Case

- Remote cases will power-up when properly field wired (or plugged in).
- After case is powered up, lift curved or flat front glass by grasping lift handle and raising (see illustration at right).
- **Note:** Illustration at right reflects flat front glass (optional). Yours may have curved front glass.
- Lift deck to check that coil fans are running.
- Evaporator coil fans should turn on.

B. Lights

- Turn lights on.
> **Remote Units:** Switch is likely at rear plenum. If not, there may be NO SWITCH (lights will come on when case powers up).
- All lights should come on at the same time. If bulbs are fluorescent, first time lighting may require a short warm-up period. LEDs have no warm-up period.
- Slightly dim / flickering of new bulbs is normal. If lights do not turn on, check raceway plugs.
- Lighting is wired in series so **all lights must be plugged in or receptacles capped** for case lights to be on. See illustration at right.
- LED Lights may have single or dual rows (depending upon model).
- **Note:** If lights do not come on, check that plug is properly inserted into socket.

C. Temperature Controller (Certain Remote Units)

- Check that compressor symbol light is on.
- Compressor will likely be identified with:
- After case has run for a few minutes, check that temperature starts to drop.
- If temperature controller does not begin cooling (in a few minutes) see temperature controller section in this operating manual for instructions.
- Remote units (without temperature controller on case): Verify that refrigeration requirements listed on serial label (found on the case) are being met.

D. Saturated Suction Temperature (Remote)

- See serial label on case for suction temperature requirements and BTU requirements.
- See serial label on case for defrost schedule and temperature termination parameters.

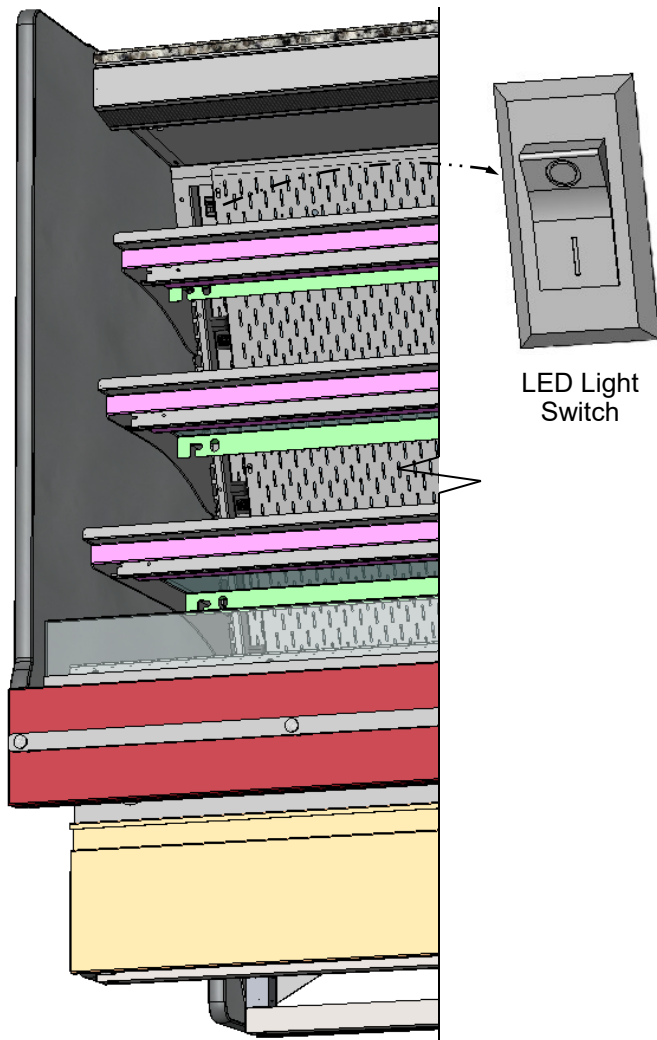

LED Light Switch

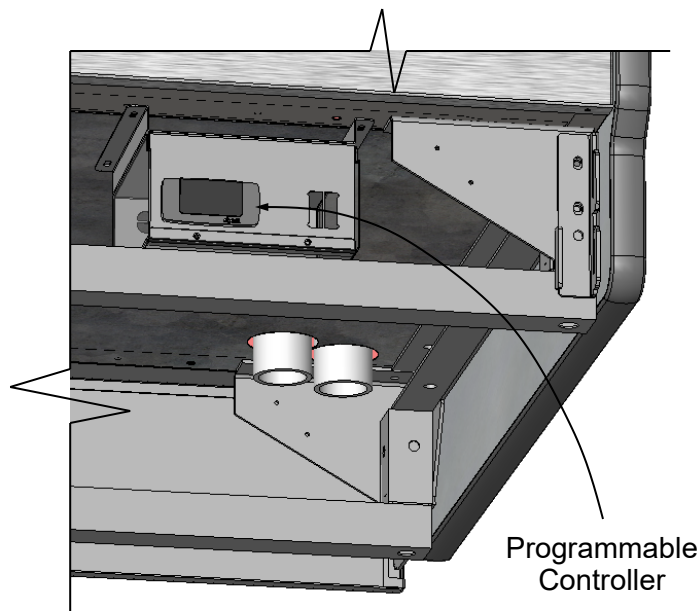

Programmable Controller

1. LED Style Light Fixtures

Removal of Faulty LED Lights:

- LED lights rarely require change-out.
- Contact Structural Concepts' Technical Service Department for replacement LED lights.
- Turn off LED light switch.
- To remove faulty LED light, follow these steps:
 - A. Disconnect plug from LED light.
 - B. Using both hands, grasp LED light assembly (with its magnetic mounting clips). Pull downward and off its shelf (or header).
 - C. Remove magnetic mounting clips from LED light by pressing against flange part of clip with thumb.

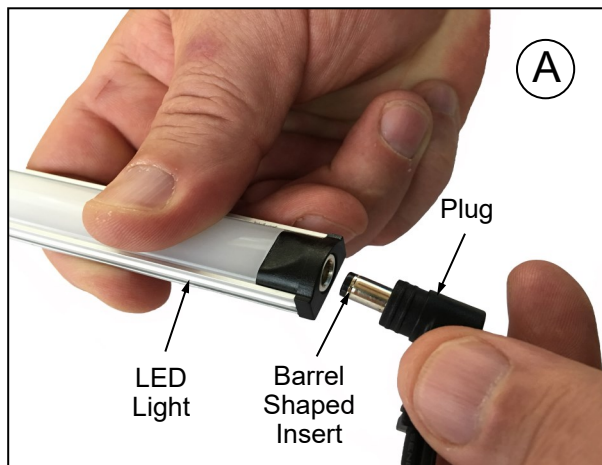

>> **Note:** Mounting clips MAY be riveted to shelf or header. In such instances, simply remove LED light from mounting clips by pressing against flange part of clips with thumb.

Replacement of LED lights:

- Attach magnetic mounting clips onto LED light.
- Adjust magnetic mounting clips so they are equally spaced on LED light.
- Reattach LED light assembly to its shelf/header.
- Position properly in shelf/header.

>> **Note:** If mounting clips are riveted to shelf (or header), attach by placing LED in base of clip and then snapping into clip at FLANGE SIDE.

- Press plug's barrel-shaped insert all the way into LED light.
- **Important:** If plug is not inserted ALL THE WAY IN the LED light's orifice, the light may not energize. See "BAD" vs. "GOOD" insertion illustrations below-right.
- Turn LED light switch back on.

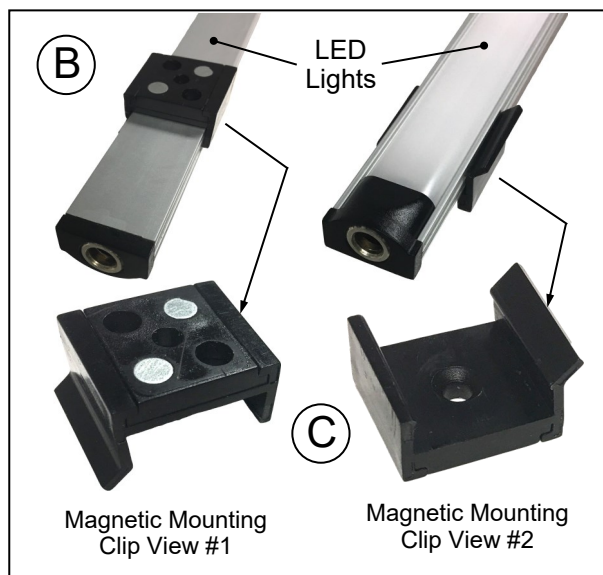

2. Bracket Retainer Removal

- To remove brackets, it may be necessary to remove nylon shipping bracket retainers.
- Pliers will be required to accomplish this task.

3. Shelf Assembly Removal

- If glass, remove shelf.
- For lighted shelving, unplug the light cord.
- Remove rear shelf support.
- Remove shelf light cover from brackets.
- Lift brackets up and out.

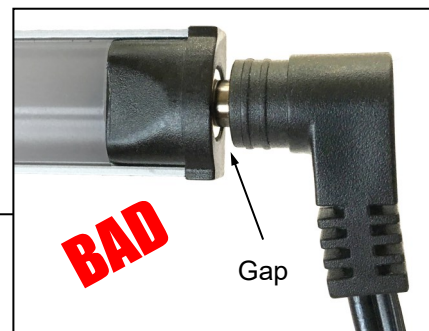

4. Drain and Expansion Valve Access

- The drain and expansion valve are both accessible from the front of the case.
- Unplug the fans (one plug per side) and remove the fastener from the access panel in the front right (or left) corner of the unit (as shown in illustration at right).
- The drain, thermostatic expansion valve (TXV) and shut-off valve (optional, depending upon model) are directly below the access panel.
- See illustration below for partially disassembled model depicting shut-off valve, drain, refrigeration lines, TXV, etc.

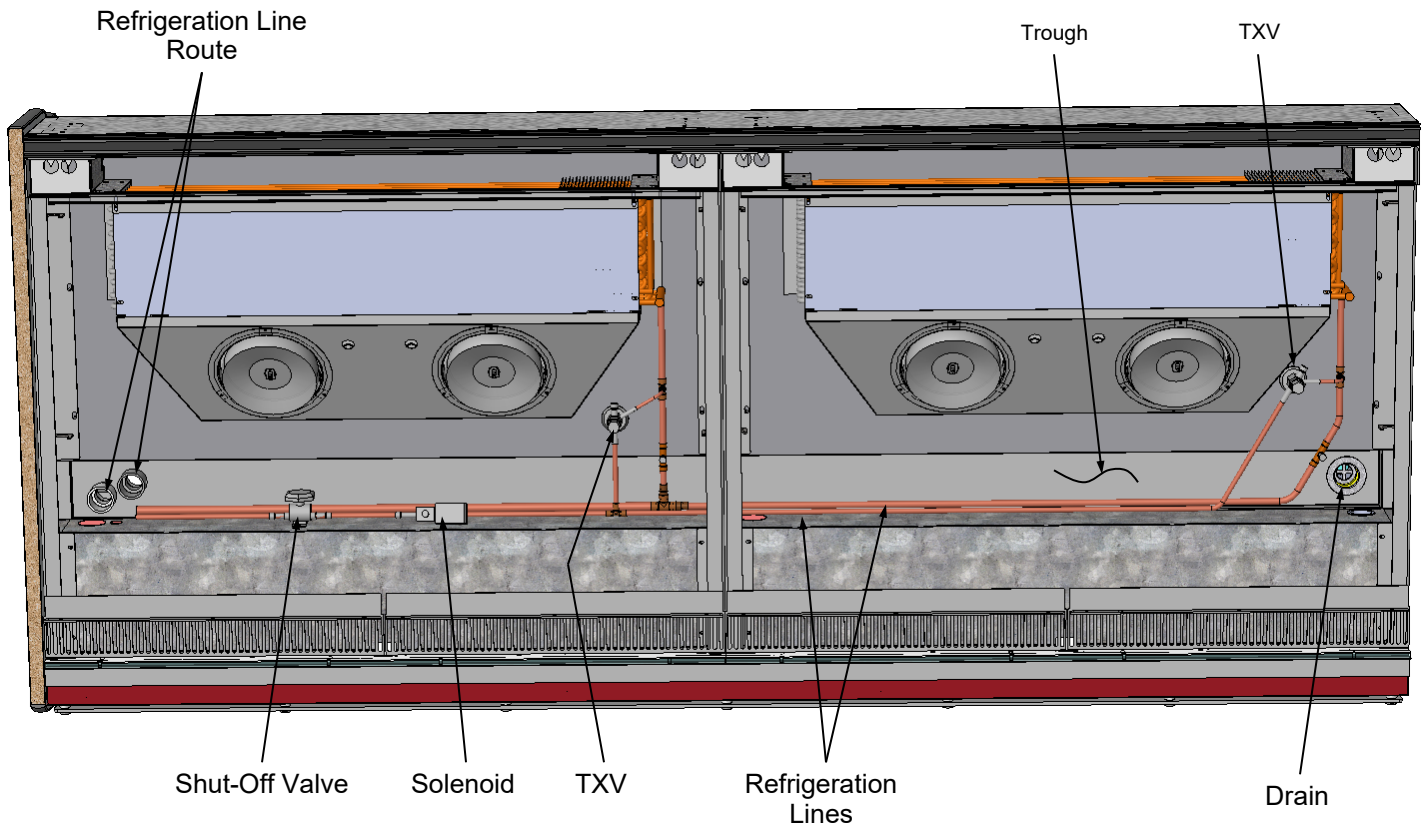

5. Removing Rear Doors

- **Note: Doors are not interchangeable.**
- There is an outer and inner door.
- Outer door is the right hand door (at case rear). If removing doors, remove outer door must be removed first.
- Inner door is left-hand door (at case rear).
- Both inner and outer doors can be removed by sliding to center of case, lifting up and out.

6. Perforated Acrylic Plenum

- Each door has a bracket that is inserted in a perforated acrylic plenum slot.
- When either rear sliding door is removed, its bracket is also removed (because it is attached).
- Perforated acrylic plenum may then be removed by sliding to center of case, lifting up and out.
- See illustrations below.

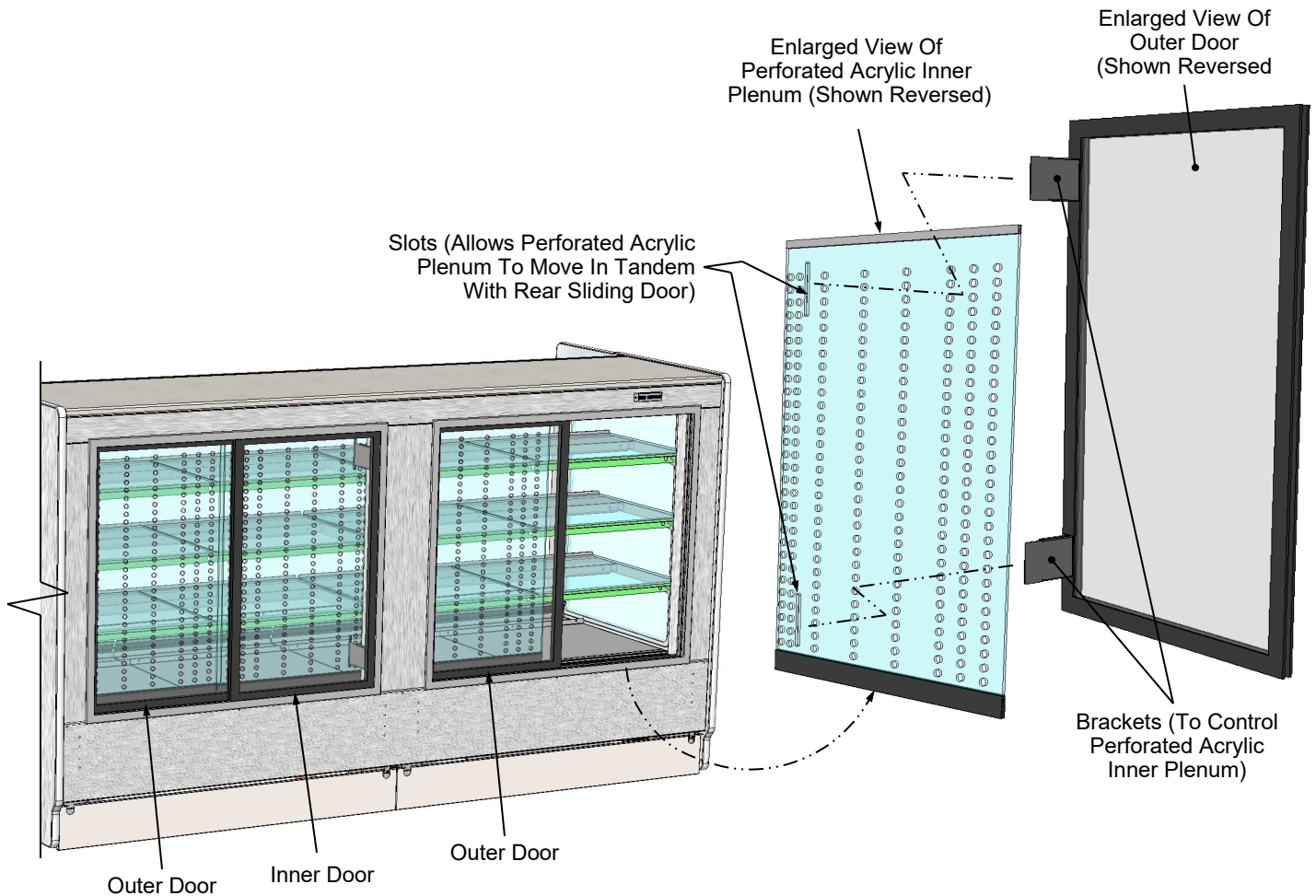

--- Model GHSSV856RLB.6988D ---

GENERAL CLEANING (TO BE PERFORMED BY STORE PERSONNEL)

AREA	FREQ.	INSTRUCTIONS
Exterior	Daily	Acrylic (Air Deflectors and Rear Perforated Plenums): Clean acrylic surfaces with a mild soap and water solution and a soft cloth. Caution! Never use ammonia-based cleaners on acrylic. Incorrect cleaning agents or abrasive cleaning cloths cause surface to 'cloud' over time.
	Daily	CaesarStone® Quartz Solid Surface: See next page.
	Daily	Shelves/Decking: Decking can be cleaned with a warm soap and water solution and soft cloth.
	Weekly	End Panels, Front Panel, Toe-Kick, etc.: Wipe off all surfaces with warm water and mild soap solution and non-abrasive cloth.
	Monthly	Under Case Cleaning: Remove either front or rear toe-kick. Vacuum under case to remove dust and dirt that may collect under case.
Interior	Daily	Glass Shelving: Clean glass shelves with a household or commercial glass cleaner.
	Weekly	Shelving Brackets / Air Return Grilles / Decking <ul style="list-style-type: none"> • Wipe off shelving brackets, air return grilles and decking with moist cloth. • Shelving brackets can be removed for more thorough cleaning. • Decking is NOT to be removed by store personnel.
	Monthly	Condenser Coil: Vacuum or brush grille condenser coil at case front. Use metal or fiber brush to remove dust and dirt that can collect on condenser coils. Be careful not to damage the fins on the coil. See INSTALLATION section in manual for side panel removal information.

ENGINEERED (SYNTHETIC) QUARTZ CARE AND MAINTENANCE

Engineered Quartz Overview	<p><u>Engineered (Synthetic) Quartz Overview:</u></p> <ul style="list-style-type: none"> • Engineered (synthetic) quartz is a 'man-made' product. It is sometimes called "engineered stone." It is made from crushed quartz particles bonded with polyester, styrene, resin, pigments and tert-butyl peroxybenzoate. • It is non-porous, mold and mildew-resistant, and impervious to odor-causing bacteria. • Slabs are specifically sized. Engineered quartz contains a maximum of 94% mineral quartz (though percentages vary). Engineered quartz is extremely resistant to damaging chemicals. • There are many engineered (synthetic) quartz brands. These include Caesarstone, Cambria, Compac, Corian, Daltile ONE, Granite HanStone, Transformations, Kowalski, LG Hausys, LG Viatera, Lunastone, Marble.com, MSI Q, Okite, Pental, Polarstone, Pompeii, Samsung, Sensa, Silestone, Stone Italiana, Vadara, Vena & Vicostone.
Routine Care	<p><u>For Daily, Routine Care and Cleaning:</u></p> <p>Engineered (synthetic) quartz require very little maintenance. Simply wipe the surface with neutral pH balanced household detergent and warm water solution with soft sponge or microfiber cloth to maintain its shine.</p> <ul style="list-style-type: none"> • To prevent fading, keep from harsh, direct sunlight for long periods of time. • General cleaners: use neutral pH balanced household detergent and warm water (4 cups of water/1 teaspoon of detergent). Or isopropyl alcohol (aka rubbing alcohol). Or use any general, all-purpose cleaner, glass cleaner or Pine Sol. Or use Clorox Wet Wipes (as they contain no bleach or and are soft). After cleaning, thoroughly rinse with water and dry with clean cloth to prevent water spots from forming. • Specifically designed cleaners for manufactured quartz: Black Diamond Stoneworks Granite Counter Cleaner, Caldrea Countertop Spray, Clark's Natural Stone Spray Cleaner, Granite Gold, Simple Green, Park & Bailey Granite & Stone Cleaner, Seventh Generation Granite & Stone Cleaner, Stone Care Quartz Clean & Shine, Stone Pro Quartz Countertop Cleaner, Weiman Quartz Countertop Cleaner and Polish.
Difficult Spills	<p><u>For Difficult Spills, Stains and Spots:</u></p> <ul style="list-style-type: none"> • Thoroughly clean with warm water and neutral pH detergent (mixture detailed above) before pursuing next steps. • Clean up high staining liquids such as coffee, tea, fruit juice, lemon juice, vinegar, wine and tomato juice right away. Use warm water and neutral pH detergent to do so. After cleaning, thoroughly rinse with water and dry. • For residues that harden as they dry (food, gum, nail polish, and paint), place wet cloth or paper towel over residue for 10 minutes (to soften its properties); then gently scrape off residue by using a plastic putty knife or plastic scraper; avoid metal blades or scrapers if possible; then clean using warm water and soap. If you must use metal razor blade or scraper, remove gray marks with soap and water. Thoroughly rinse with water and dry to prevent water spots. • Difficult spots may need to be treated with solutions/chemicals BEYOND warm water and neutral pH detergents: A. Water/white vinegar mixture: 2 cups of water with 1 tablespoon of white vinegar in spray bottle; spray surface; allow solution to sit for 2 minutes; wipe off with soft cloth or sponge. B. Soft Scrub Liquid Gel: Apply gel to cloth or sponge (not directly to quartz surface); wipe the area in a circular motion; repeat until spot is removed. C. Goo Gone adhesive remover (for sticky residue). Thoroughly rinse the surface with water and wipe dry to prevent water spots. • Water stain removal: 1 part vinegar + 3 parts baking soda in warm water. Dip cloth in mixture and thoroughly soak stain. Leave for 5-10 minutes; then scrub area with soft brush. Rinse with water and dry with clean cloth.
Extreme Heat Protection	<p><u>Extreme Heat Protection:</u></p> <ul style="list-style-type: none"> • Engineered quartz is extremely resistant to heat, and can withstand moderately high temperatures for brief periods of time without being damaged. • Engineered quartz CAN BE damaged by sudden and extreme temperature changes; thus, use a trivet or a hot pad to protect its surface from hot pans, hot dishes or small appliances that may reach high temperatures.
Chemicals To Avoid	<p><u>Chemicals To Avoid:</u></p> <ul style="list-style-type: none"> • Nail polish remover (acetone), oil soaps, and furniture cleaners or paint strippers that contain trichloroethane or methylene chloride. • Chemicals with an alkaline level of pH >10 (oven cleaners, chloring bleach, lacquer thinner, ammonia, tub and tile cleaner, borax, etc.) • Chlorinated solvents (trichloroethylene or methylene chloride) • Concentrated acids (hydrocyanic acid, hydrofluoric acid, hydrochloric acid, sulfuric acid, nitric acid or CLR) <p>Caution must be used for the following products on engineered quartz surfaces:</p> <ul style="list-style-type: none"> • Avoid using products containing oils or powders as may leave a residue. • Avoid abrasive scrubs/cleaners (such as Ajax, Comet, Scotch-Brite or oven cleaner) as it dull or discolor the finish. <p>Common stains like coffee, food, makeup, permanent markers, etc.:</p> <ul style="list-style-type: none"> • Apply the appropriate cleaner with a paper towel and wipe. If necessary, soak with paper towels from 3-10 minutes. • Scrub the area with a non-abrasive cloth or sponge. Rinse and dry thoroughly.
Preventing Scratches	<p><u>Scratch Deterrence:</u> Engineered quartz surfaces are scratch RESISTANT. However, they CAN be scratched or marred by certain utensils or cleaning materials.</p> <ul style="list-style-type: none"> • Use a cutting board to avoid damaging the quartz surface and knives. • Never use abrasive scouring pads, steel wool soap pads, Brillo® pads or "Magic Erasers."

TROUBLESHOOTING (TO BE PERFORMED BY STORE PERSONNEL)

CONDITION	TROUBLESHOOTING
Case Not Lining Up	See INSTALLATION section in this manual for instructions on properly aligning case (alongside other cases) and shimming rails.
Door Is Loose, Wobbles Or Falls Out Of Door Frame	Door track (in door frame) or door glides (on door) may be wearing out or malfunctioning. See STRUCTURAL CONCEPTS TECHNICAL SERVICE CONTACT INFORMATION in manual to order replacement parts.
Water Is On The Floor	Call service provider.
Fan Emits Excessive Noise	Call service provider.
Case Lights Are Not Working	Check that light switch is in the <i>on</i> position.
	Check that ALL of the light cords and plugs are properly connected. See MAINTENANCE FUNDAMENTALS - LED LIGHTS section in manual.
	If case lights still do not come on, call service provider.
Case is Not Holding Proper Temperature	If a large amount of warm product was added to the case, it will take time for the temperature to adjust. Product must be pre-chilled before placing in case.
	Check that the case is not in the sun or near a heat or air-conditioning vent. See OVERVIEW / TECHNICAL INFORMATION / WARNINGS section in this manual for specifics.
	Check that case is NOT located near outside doors as temperature fluctuation can hinder unit's ability to maintain temperature.
	Check air return grilles (area at front of decking) for obstructions. DO NOT set product on air grilles as this will prevent proper airflow!
	If case still is not holding proper temperature, call service provider.

GENERAL CLEANING (TO BE PERFORMED BY TRAINED SERVICE PROVIDERS ONLY)

AREA	FREQUENCY	INSTRUCTIONS
Tub Area (Under Decking)	Quarterly	<p><u>Tub Area (Evaporator Coil, Drain, Fans, Brackets, Fan Shroud, etc):</u></p> <p><i>Caution! Disconnect power from the case before cleaning tub, coil, fan, motor and drain area!</i></p> <ul style="list-style-type: none">• Use vacuum to clean entire area.• After vacuuming, clean area with warm water, clean cloth, and mild soap solution.• Remove any debris that may clog drain.• Wipe down fan blades, motors and brackets and fan shroud with moist cloth.

CONDITION	TROUBLESHOOTING
Case Not Lining Up	See INSTALLATION section in this manual for instructions on properly aligning case (alongside other cases) and adjusting levelers.
Water Is On The Floor	<p>Caution! Water on flooring can cause much damage! Until cause is determined (and repaired), follow these procedures:</p> <ul style="list-style-type: none"> • Use wet-dry vacuum (or mop & bucket) to remove standing water. • Use 'catch pans' for water to drain into. Swap out regularly until case has completely drained.
	Check that the drain trap is free of debris.
	<p>Check store conditions.</p> <ul style="list-style-type: none"> • To prevent condensation in NSF/ANSI Type I environments, maximum conditions are to be 55% relative humidity / 75° Fahrenheit. • For NSF/ANSI Type II environments, maximum conditions are to be 55% relative humidity / 80° Fahrenheit. • If you are unsure if your unit is classified as NSF/ANSI Type I or Type II, see tag next to serial label on your case.
Fan Emits Excessive Noise	Check that the case is aligned, level and plumb.
	Check evaporator fans for cleanliness.
	Unplug/power off fan motors. Check motor shaft for bearing wear.
	Check that fan motors are securely mounted in brackets.
	Verify that fan blades are securely mounted to fan motor.
	Check that nothing is preventing blade rotation.
	Check that the fan shroud is properly secured.
Fans Are Not Working	Check that the MAIN power switch is on (or case is properly connected to power source).
	Check that fans are plugged in at the fan shroud.
	Check for foreign material obstructing fan performance.
	Check that fan blades freely rotate within fan shrouds
	Check that power is going to fans
	Check that fan wiring is connected on terminal blocks.
Digital Control Display Is Blank	Check that the MAIN power switch is on.
	Check the circuit breaker box for tripped circuits.
System Not Operating	Check that the utility power is on.
	Check that the MAIN power switch is on.
	Check the circuit breaker box for tripped circuits.

CONDITION	TROUBLESHOOTING
Case Lights Are Not Working	Check that Light switch is in the <i>on</i> position.
	Check that ALL of the light cords and plugs are properly connected. See MAINTENANCE FUNDAMENTALS - LED LIGHTS section in manual.
	Check voltage at LED drivers. If voltage is entering but not exiting, LED driver may be faulty.
Control Display Is Flashing	See your case's serial label for your model's specified settings. See SERIAL LABEL LOCATION & INFORMATION LISTED / TECH INFO & SERVICE for label location, etc.
Case Is Not Holding Temperature	If a large amount of warm product was added to the case, it will take time for the temperature to adjust. Unit needs product to be pre-chilled.
	Temperature changes during defrost mode but will return to normal. Fourth LED will indicate defrost cycle in progress.
	Check that case is not in sun or near a heat or air-conditioning vent. See OVERVIEW AND WARNINGS section in manual for adverse conditions/spacing issue parameters.
	If case is located near outside doors, temperature fluctuation can hinder unit's ability to maintain temperature. See OVERVIEW AND WARNINGS section in manual for adverse conditions/spacing issue parameters.
	Check air return grilles for obstructions.

Serial Label Location & Information Listed / Technical Information & Service

- Serial labels are affixed at a wide range of places (on the header, near thermostat, at case rear, behind panels/toe-kicks, on electrical boxes, etc.).
- Serial labels contain electrical, temperature and refrigeration information, as well as regulatory standards to which the case conforms.

- Sample serial label is shown. A variety of models is displayed on serial label for illustration purposes only. Your case's serial label will reflect only one model.
- For additional technical information and service, see the *TECHNICAL SERVICE* page in this manual for instructions on contacting Structural Concepts' Technical Service Department.

Structural Concepts® **Fusion** MODEL NRS3648RXV-SAMPLE
 888 E. Porter Rd - Muskegon, MI 49441 SERIAL NO. 12345X30DZ098765

 Intertek

 Intertek

Blend Addenda Grocerant

Harmony Impulse

Oasis Reveal

SAMPLE ONLY

3048256 Conforms to UL Std. 471 Conforms to NSF/ANSI Stds. 2 & 7 CERTIFIED TO CAN/CSA STD C22.2 NO 120 Super Heat Temp Defrost	ELECTRICAL RATING REFRIGERANT DESIGN PRESSURE MINIMUM CIRCUIT AMPACITY MAXIMUM OVERCURRENT 6-8 °F 6 defrosts per day, 45 °F	120/1/60 16 A R513A AMOUNT 50 OZ HIGH 186 LOW 88 20A 20A FOR PARTS AND SERVICE CALL 1-800-433-9490
--	---	--

SCAN FOR PRODUCT LITERATURE

 Sample QR Code

SAMPLE ONLY *SAMPLE ONLY* *SAMPLE ONLY*

SAMPLE ONLY *SAMPLE ONLY*

--- Sample Serial Label For Refrigerated Cases ---



Determine Which Programmable Controller Is On Your Case (Controllers That Are Commonly Used By Structural Concepts Are Shown Below). Your Particular Programmable Controller May Differ From Units Shown.



Carel® PJEZ Platform



Carel® ir33 Platform



Carel® iJF Platform



Dixell® XM670K-XM679K Platform

To Access Information About The Programmable Controller That Is Used On Your Case, Follow These Instructions:

- > If Viewing This Document on Smart Phone, Tablet or Computer, Select/Click On The QR Code at Right.
- > If Viewing This Document In Print (Hard Copy), Scan The QR Code at Right With Your Smart Phone or Tablet.

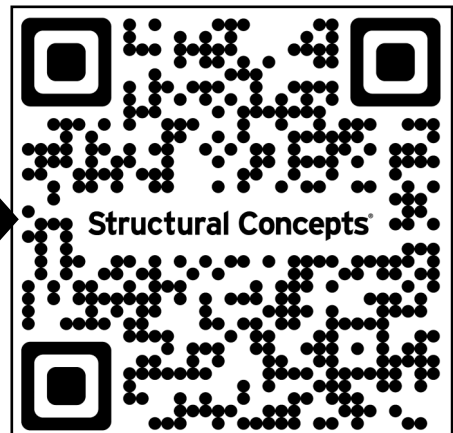
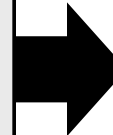

STRUCTURAL CONCEPTS TECHNICAL SERVICE CONTACT INFORMATION & LIMITED WARRANTY

TECH SERVICE/WARRANTY CONTACT INFO:
1 (800) 433-9490 / EXTENSION 1
DAYS/HOURS AVAILABLE:
MONDAY - FRIDAY (CLOSED HOLIDAYS)
8:00 AM to 8:00 PM EST

**YOU MUST HAVE THE FOLLOWING INFO AVAILABLE
BEFORE CONTACTING STRUCTURAL CONCEPTS:**
SERIAL NO. / MODEL NO. / STORE NO. / STORE
ADDRESS / DETAILS (PHOTOS, LEAK LOCATIONS,
DAMAGE, STORE'S AMBIENT CONDITIONS, ETC.)

**To Access The Limited Warranty To Your
Case, Follow These Instructions:**

- > If Viewing This Document on Smart Phone, Tablet or Computer, Select/Click On The QR Code at Right.
- > If Viewing This Document In Print (Hard Copy), Scan The QR Code at Right With Your Smart Phone or Tablet.

